

TL

2-Way / 3-Way Globe Valve (DN15-50)

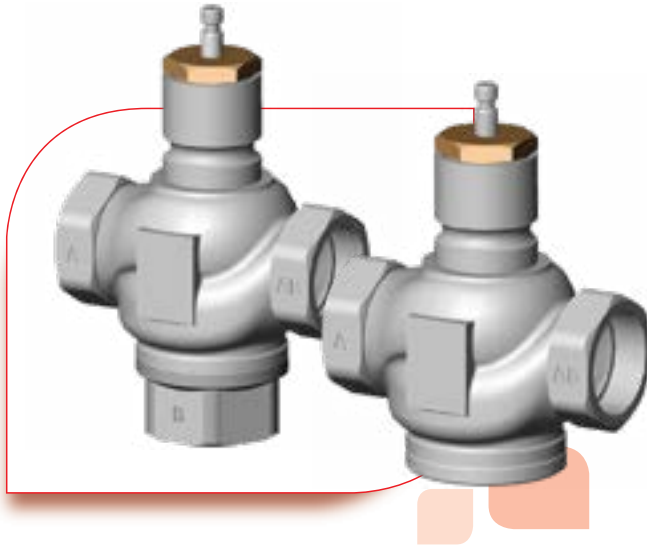

Features



Perfect Control Curve

The rangeability of valve is 100:1, equipped with TW...series actuator which can get a perfect equal-percentage control curve.

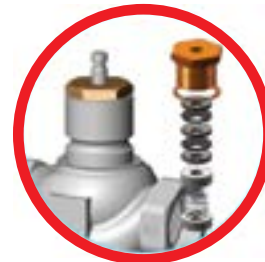

V-ring Sealing Gland+ Spring Auto-compensation

Due to V-ring shape of the sealing gland, the effects of the inner hole shrinkage and cylindrical expansion of the sealing gland in the case of pressing by the spring, which ensures the sealing of the stem part is effective for a long time.



Low Leakage Rate

The leakage rate of valve is no more than 0.01% Kvs, the valve core and valve seat sealing surface are all stainless steel which could avoid the damage caused by debris in medium.



High-quality Material

The valve body is made of high- quality stainless steel, precision casting process makes the appearance of exquisite valve, excellent material strength is much higher than the copper valve.



TL

2-Way / 3-Way Globe Valve (DN15-50)



Type Summary
Threaded valve PN16

Series	TW500...	TW1000...	TW3000...
Actuator Rated Stroke	30mm	30mm	50mm
Nominal Output Force	500N	1000N	3000N
Icon			
Proportional Type 0(2)-10VDC,0(4)-20mA	TW500-XD24-S.12	TW1000-XD24-S.12	TW1001-XD24-S.14
3-position Type(on/off)	TW500-XD24-S.12	TW1000-XD24-S.12	TW1001-XD24-S.14
RS485 bus and NFC(optional)	TW500-XD24-S485.12	TW1000-XD24-S485.12	TW1001-XD24-S485.14
2 SPDT Feedback Function(optional)	TW500-XD24-SF2.12	TW1000-XD24-SF2.12	TW1001-XD24-SF2.14

Valve Body		Type	DN [mm]	Stroke [mm]	Max. Flow Parameter Kvs [m3/h]	ΔP_s [MPa]	ΔP_s [MPa]	ΔP_s [MPa]
PN16, Medium Temp. -25 ~ 130°C		TL15-2VBC-S.12-KVS0.63	DN15	10	0.63	0.90		
		TL15-2VBC-S.12-KVS1.00	DN15	10	1.0	0.90		
		TL15-2VBC-S.12-KVS1.60	DN15	10	1.6	0.90		
		TL15-2VBC-S.12-KVS2.50	DN15	10	2.5	0.90		
		TL15-2VBC-S.12	DN15	10	4.0	0.90		
		TL20-2VBC-S.12	DN20	10	6.3	0.90		
		TL25-2VBC-S.12	DN25	15	10	0.60		
		TL32-2VBC-S.12	DN32	20	16	0.40		
		TL40-2VBC-S.12	DN40	20	25	0.20	0.45	
TL50-2VBC-S.12	DN50	20	40		0.30	1.0		
PN16, Medium Temp. -25 ~ 130°C		TL15-3VBC-S.12-KVS0.63	DN15	10	0.63	0.90		
		TL15-3VBC-S.12-KVS1.00	DN15	10	1.0	0.90		
		TL15-3VBC-S.12-KVS1.60	DN15	10	1.6	0.90		
		TL15-3VBC-S.12-KVS2.50	DN15	10	2.5	0.90		
		TL15-3VBC-S.12	DN15	10	4.0	0.90		
		TL20-3VBC-S.12	DN20	10	6.3	0.90		
		TL25-3VBC-S.12	DN25	15	10	0.60		
		TL32-3VBC-S.12	DN32	20	16	0.40		
		TL40-3VBC-S.12	DN40	20	25	0.25	0.45	
TL50-3VBC-S.12	DN50	20	40		0.30	1.0		







TL

2-Way / 3-Way Globe Valve (DN15-50)



Type Summary

Threaded valve PN25

Series				TW500...	TW1000...	TW3000...	
Actuator Rated Stroke				30mm	30mm	50mm	
Nominal Output Force				500N	1000N	3000N	
Icon							
Proportional Type 0(2)~10VDC,0(4)~20mA				TW500-XD24-S.12	TW1000-XD24-S.12	TW1001-XD24-S.14	
3-position Type(on/off)				TW500-XD24-S.12	TW1000-XD24-S.12	TW1001-XD24-S.14	
RS485 bus and NFC(optional)				TW500-XD24-S485.12	TW1000-XD24-S485.12	TW1001-XD24-S485.14	
2 SPDT Feedback Function(optional)				TW500-XD24-SF2.12	TW1000-XD24-SF2.12	TW1001-XD24-SF2.14	
Valve Body	Type	DN [mm]	Stroke [mm]	Max. Flow Parameter Kvs [m3/h]	ΔP_s [MPa]	ΔP_s [MPa]	ΔP_s [MPa]
PN25 , Medium Temp. :25 ~ 130°C  Female threaded water valve	TL15-2VBD-S.12-KVS0.63	DN15	10	0.63	0.90		
	TL15-2VBD-S.12-KVS1.00	DN15	10	1.0	0.90		
	TL15-2VBD-S.12-KVS1.60	DN15	10	1.6	0.90		
	TL15-2VBD-S.12-KVS2.50	DN15	10	2.5	0.90		
	TL15-2VBD-S.12	DN15	10	4.0	0.90		
	TL20-2VBD-S.12	DN20	10	6.3	0.90		
	TL25-2VBD-S.12	DN25	15	10	0.60		
	TL32-2VBD-S.12	DN32	20	16	0.40		
	TL40-2VBD-S.12	DN40	20	25	0.20	0.45	
	TL50-2VBD-S.12	DN50	20	40		0.30	1
PN25 , Medium Temp. :25 ~ 130°C  Female threaded water valve	TL15-3VBD-S.12-KVS0.63	DN15	10	0.63	0.90		
	TL15-3VBD-S.12-KVS1.00	DN15	10	1.0	0.90		
	TL15-3VBD-S.12-KVS1.60	DN15	10	1.6	0.90		
	TL15-3VBD-S.12-KVS2.50	DN15	10	2.5	0.90		
	TL15-3VBD-S.12	DN15	10	4.0	0.90		
	TL20-3VBD-S.12	DN20	10	6.3	0.90		
	TL25-3VBD-S.12	DN25	15	10	0.60		
	TL32-3VBD-S.12	DN32	20	16	0.40		
	TL40-3VBD-S.12	DN40	20	25	0.25	0.45	
	TL50-3VBD-S.12	DN50	20	40		0.30	1



TL

2-Way / 3-Way Globe Valve (DN15-50)



Flow Characteristic

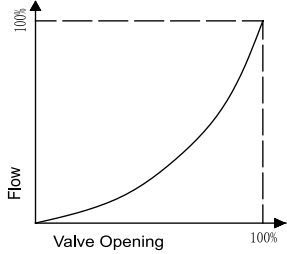

A-AB Equal-percentage Flow Characteristic

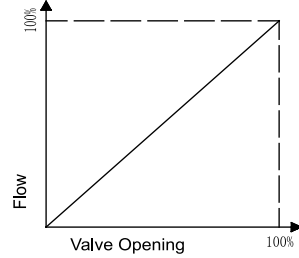

B-AB Equal-linear Flow Characteristic

Relationship between Differential Pressure and Flow

$$Kvs = \frac{V}{\sqrt{\frac{\Delta P}{100}}}$$

ΔP : Differential pressure when valve is full open (Unit: KPa)

V: Rating flow at the ΔP (Unit: m³/h)

Kvs: Nominal flow coefficient, which refer to the flow when medium (Density= 1g/cm³) go through the full open control valve, whose ΔP is 100KvPa.

Structure Characteristic

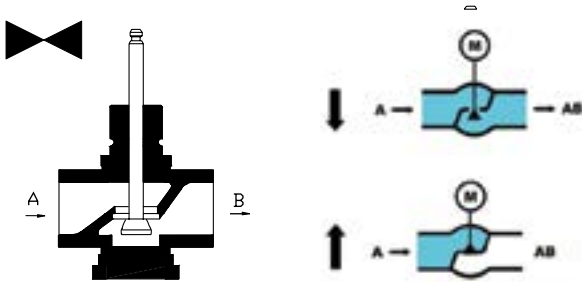

2-port Valve

When the valve stem retracts, flow increases from A to AB.

When the valve stem extends, flow decreases from A to AB.

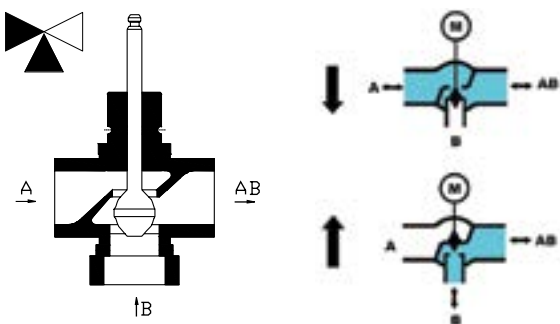

3-port Mixing Valve

When the valve stem retracts, A port flow increases and B port flow decreases.

When the valve stem extends, A port flow decreases, B port flow increases.

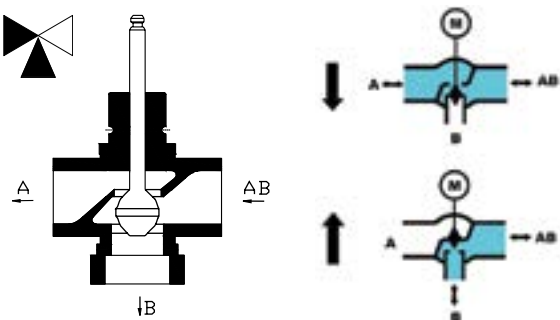

3-port Diverting Valve

When the valve stem retracts, A port flow increases and B port flow decreases.

When the valve stem extends, A port flow decreases, B port flow increases.



TL

2-Way / 3-Way Globe Valve (DN15-50)



Installation Instruction

1. Please note that the medium flow direction in valve should be consistent with the medium of pipeline!

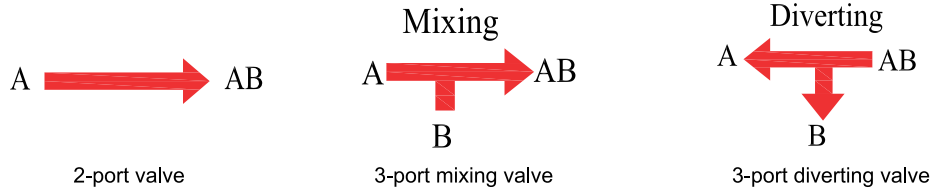

2. Please pay attention to the valve mounting orientation!

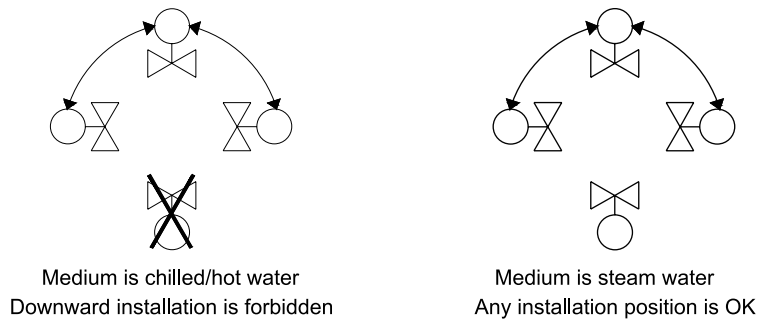

3. Valve can be installed in the water supply pipe or return water pipe (priority selection). Besides, filter and check valve are recommended to be installed. When the medium is steam, install draw off valve in the pipe can remove the condensed water, or it will affect the lifetime of valve (installed on the return water pipe can control the water flow more smoothly, meanwhile the return water temperature is lower which can extend the lifetime of valve).
4. Valve and actuator can be assembled easily. Neither need any special tools nor need to do any adjustment.

Installation Orientation

1. Prepare for assembling actuator, take down the fixed fitting, and disengage the clip.

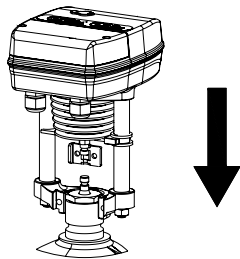

2. Make the actuator's stem is concentric with the valve's stem which can be observed from the hole, and make these two connecting faces keep coinciding. Then lock the two screws on the clip.

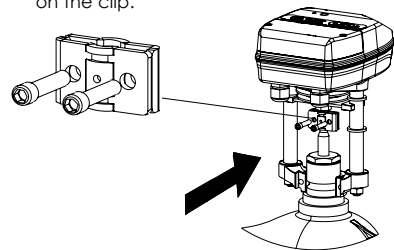

3. Pulling the fixed fitting to the groove and locking by two screws.

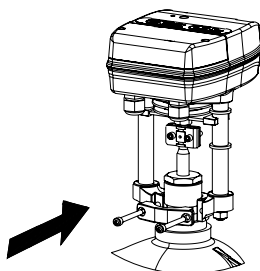

4. The status after assembled, face and back.

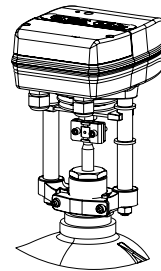



TL

2-Way / 3-Way Globe Valve (DN15-50)



Dimension Figure

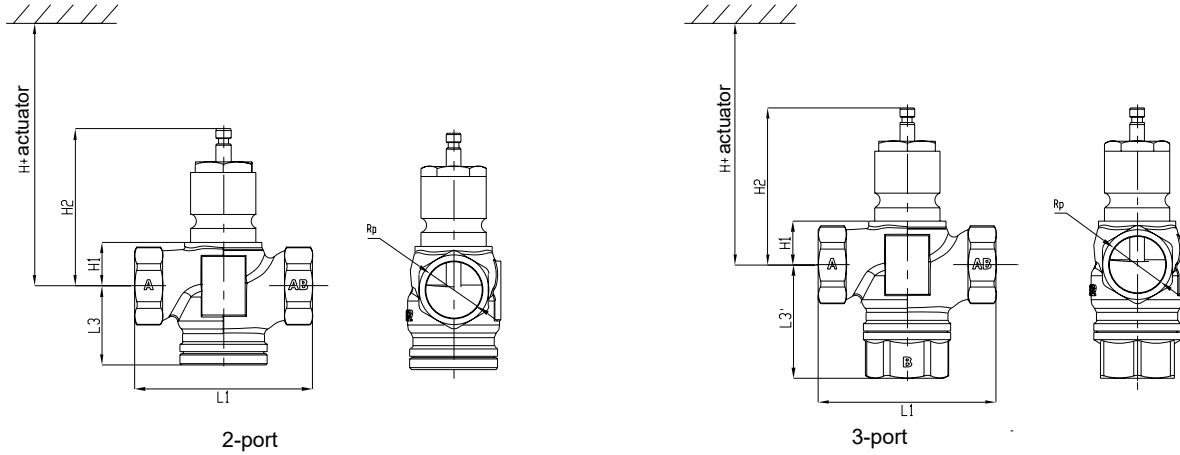

DN	Rp	L1 mm	2-port L3 mm	3-port L3 mm	H1 mm	H2 mm	H mm (500N / 1000N)	2-port Net Weight (kg)	3-port Net Weight (kg)
15	1/2"	75	38	53	20	97	335	1	1.1
20	3/4"	80	38	55	20	97	335	1.2	1.2
25	1"	105	43	60	26	103	341	1.6	1.6
32	1-1/4"	120	52.5	76	29.5	106	345	2	2.1
40	1-1/2"	130	53	79	36	113	351	2.5	2.6
50	2"	150	68	92	51	128	366	3.8	3.8

Technical Parameters

Spare Parts Material	
Caliber range	DN15~DN500
Permissible pressure	PN16, CPN25 are optional
Connection standard	Flanged connection ISO7005-2
Leakage rate 2-port 3-port	.0...0.01% Kvs 0...0.02% Kvs
Permissible medium Water valve (-25~130°C) Steam valve (2~180°C)	Chilled/hot water, glycol under 50% Saturated steam (<0.69MPa), Overheated steam (<180°C)
Steam valve (2~220°C) Steam valve (2~450°C)	Overheated steam (≤220°C) Overheated steam (≤450°C)
Rangeability	>100:1
Flow characteristic	A-AB equal-percentage flow characteristic B-AB equal-linear flow characteristic
Life cycles	100 thousand cycles

Spare Parts Material	
Valve body	Ductile iron QT450-10
Valve stem	Stainless steel
Valve core	Stainless steel
Sealing ring	PTFE